

COMMERCIAL CONDUCTIVE BATCH FREEZE DRYER GPC MODEL SPECIFICATION SHEET

FD1200

CO₂ (R744) Refrigerant
1200 kg Sublimation Capacity
113.7m² shelf area

Revision: V6.1 2024

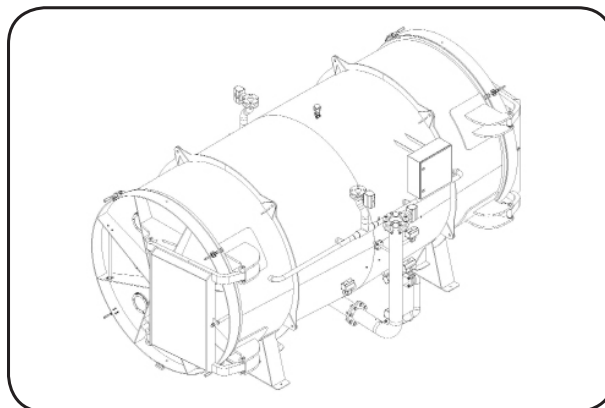

PERFORMANCE

Shelf capacity	113.7m ² on 19 shelves
Performance ice test (18hrs)	1200 kg ice
Average yield of dry product per cycle	240 kg based on 1200 kg wet product @ 80% moisture
Potential heat energy recovery	110 kW
Peak power requirement	150 kW
Est. Energy consumption	1.5 kWh / kg
Est. Typical operational power consumption (Dry)	82 kW

SPECIFICATION

Ice condenser capacity	1200 kg
Ice condenser temperature	-40°C
Shelf temperature range	-20°C to 70°C
Shelf spacing (mm)	35mm
Product tray material	Food grade anodised aluminium
Number of product trays	224 per cycle (2 sets supplied)
Heating / cooling medium	Heat Transfer Fluid
Number of doors on product chamber	2 (one at each end)
Plant equipment	Plant on separate skid

DIMENSIONS

Chamber footprint	5.12m (L) x 2.80m (W) x 2.58m (H)
Plant skid footprint	5.80m (L) x 2.00m (W) x 2.35m (H)
Weight	18,200 kg
Product trays size	1025mm x 495mm x 20mm

A LITTLE BACKGROUND

Experience and Expertise

Cuddon Freeze Dry has been developing and manufacturing freeze drying equipment since 1963. With nearly 60 years experience and more than 400 installations worldwide, our products are highly respected.

Cuddon freeze dryers are MAF approved and used in the following industries:

- Dairy
- Food Processing
- Research
- Nutraceuticals
- Pet Food
- Disaster Recovery



Quality and Service

All Cuddon Freeze Dry manufacturing is completed under ISO9001 accreditation. This ensures consistency, reliability and quality workmanship. Cuddon Ltd has been ISO9001 certified since 1993.

Our dedicated staff pride themselves on providing world class after sales service via the Internet, telephone or in person where required.

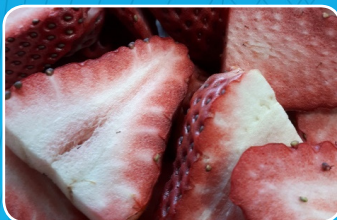

McARTNEY STREET
PO BOX 64
BLENHEIM
NEW ZEALAND

T: +64 3 578 4299
F: +64 3 578 4294
E: sales@cuddonfreedry.com
W: cuddonfreedry.com

The Cuddon GPC (CO₂/R744) freeze dryer at a glance:

Designed specifically for use with the environmentally compliant refrigerant gas Carbon Dioxide (CO₂), also referred to as R744, the new GPC range of Cuddon Freeze Dryers is designed with environmental sustainability, high performance, consistency of results, reduced maintenance and whole of life costs at the very core. The most advanced commercial freeze dryers on the market, manufactured by a freeze dry manufacturer with nearly 60 years of experience in the Freeze Dry and commercial refrigeration field, Cuddon Freeze Dry continues to deliver excellence in sublimation technology.

The Cuddon Freeze Dryer is a batch style conductive commercial scale freeze dryer, delivering consistent high quality lyophilisation processing. The liquid filled shelves ensures fine control of sublimation temperature with minimal heat; an energy saving measure as well as risk mitigation against scorching or burning of the product that can be associated with radiant freeze dryers. Batch freeze drying on specially designed anodised aluminium food grade trays enables absolute flexibility of use for different product types and unrivalled quality control of product batches.

Manufactured to the very highest standards, the product chamber is manufactured from grade 304 stainless steel & product contact is limited to the product trays; sanitation and hygiene compliance are assured when combined with a robust cleaning and quality regimes within your facility.

Designed to run with minimal maintenance hence optimising operational availability, the Cuddon Freeze Dryer GPC range minimises the environmental footprint of your freeze dry operations, while also delivering significant Whole of Life Cost (WOLC) savings against previous models without any loss in performance or drying quality.

Environmental Design Features:

- Environmentally neutral Carbon Dioxide (CO₂ / R744) refrigerant, with a Global Warming Potential (GWP) of just '1'.
- Hard wearing and long lasting stainless steel product chamber and modules can be re-engineered as required in the future and are ultimately recyclable.
- Aluminium product trays have superior heat transfer properties to steel, delivering lower peak power draw and shorter cycle times; reduced energy costs per cycle & improved product capacity per annum.
- Excess heat may be recovered from plant & equipment for use elsewhere in the factory through the Excess Heat Recovery optional upgrade; reducing energy consumption costs (FD600 & above).
- Elimination of oil disposal costs during maintenance through the use of a vacuum dry pump as standard.
- Plant and equipment selected for efficiency and performance.

Performance Design Features:

- Optimised for sublimation performance, ease of operation, flexibility of use and commercial scalability delivering the very best commercial scale freeze dry output.
- Designed specifically for CO₂/R744 refrigerant, the high performance of the previous Cuddon Freeze Dry GP (R507) range has been at least matched and in many criteria significantly improved through multiple design improvements.
- Freeze dry recipes developed in other Cuddon Freeze Dryers are transferable to alternate size models, meaning ease of commercial scale up and flexibility of use.
- All models utilise a common tray size, enabling pre-processing to be optimised regardless of size of commercial freeze dryer and the option of using the Cuddon product trays throughout your production line, reducing complexity of your production line.
- Includes Freeze in Place function – negating the need for a separate freezer for Start Up companies, or minimising the risk of double handling for high value products due to external freezing.
- Food grade product trays are the only contact surface for the product, meaning less cleaning burden and reduced risk of cross-product contamination. Especially designed with curved edges, this eliminates product traps and ensures easier product removal when dry.
- Control system is optimised to ensure all systems work efficiently in harmony, with an intuitive HMI touchscreen with remote operations and monitoring facilitated via VPN.

Cuddon Freeze Dry, the environmental choice for quality & performance.